



The Safety Company

FlameGard® 5 Test Lamp

for Flame Detection



The information and technical data disclosed in this document may be used and disseminated only for the purposes and to the extent specifically authorized in writing by MSA.

Instruction Manual

MSA reserves the right to change published specifications and designs without prior notice.

Part No.
Revision

MAN5TL
0

This page is intentionally left blank.



Warning: Do not leave battery uncharged. It will result in permanent battery damage

Page intentionally left blank

Table of Contents

ABOUT THIS MANUAL	VII
Format Conventions	vii
Notes, Cautions, and Warnings	vii
Contacting Customer Support.....	vii
1.0 INTRODUCTION	8
1.1 Notice	8
1.2 Special Warnings	8
1.3 Description	8
1.4 Upon Receiving.....	8
1.5 Test Lamp Operating Principle	10
2.0 QUICK START GUIDE	11
3.0 TEST LAMP COMPONENTS.....	12
3.1 Lamp Housing Assembly	12
3.2 Microcontroller.....	12
3.3 Rotary Switch Setting.....	12
3.4 Rechargeable Battery	12
3.5 Power Jack.....	12
3.6 Push Button.....	12
3.7 Aluminum Case and Cap	13
3.8 Battery Charge State Indicator.....	13
4.0 USE AND OPERATION	14
5.0 TEST LAMP MAINTENANCE AND WARRANTY	17
5.1 Maintenance.....	17
5.2 Cleaning the Sapphire Window.....	17
5.3 Recharging the Battery	18
5.4 Obtaining Service.....	18
5.5 Warranty.....	18
6.0 TROUBLESHOOTING GUIDE	20
7.0 CUSTOMER SUPPORT	21
7.1 MSA Office	21
7.2 Other Sources for Help	21
8.0 APPENDIX.....	22
8.1 Specifications	22
8.2 Regulatory Agency Approvals.....	22
8.2.1 Regulatory Agencies	22
8.2.2 Classification Area and Protection Methods	23

Table of Figures

Figure 1: FlameGard 5 Test Lamp	8
Figure 2: FlameGard 5 Test Lamp Battery Connection.....	9
Figure 3: Approximate Distance between FlameGard 5 Test Lamp and a Flame Detector	11
Figure 4: Reflector Mounting in Body	14
Figure 5: Location of Functional Board under Lamp Assembly	15

Table of Tables

Table 1: Charge State Indicator.....	13
Table 2: Detector Test Mode Initiation or/Detector Alarm Trigger with FlameGard 5 Test Lamp	16
Table 3: Troubleshooting Table.....	20

About This Manual

This manual provides instructions for operating, and maintaining the MSA FlameGard 5 Test Lamp. The intended audience includes installation personnel, field service technicians, and other technical staff involved in using the Test Lamp.

Format Conventions

Several format conventions are used throughout this manual for Notes, Cautions, and Warnings. These conventions are described below.

Notes, Cautions, and Warnings

NOTE: Notes provide supplementary details such as exception conditions, alternate methods for a task, time saving tips, and references to related information.



CAUTION: These notices describe precautions to prevent hazardous conditions that may damage the equipment.



WARNING: These notices describe precautions to prevent hazardous conditions that may cause injury to people working with the equipment.

Contacting Customer Support

For additional product information not contained in this manual, please contact MSA Customer Support. Refer to Section 7.0 for contact information.

1.0 Introduction



Figure 1: FlameGard 5 Test Lamp

1.1 Notice

All information contained in this instruction manual applies only to the setup and operation of the FlameGard 5 Test Lamp with flame detectors provided by MSA. The sale of the test lamp does not license the user to reproduce MSA drawings or to utilize any information contained in this manual without prior written permission.

The FlameGard 5 Test Lamp is easy to set up and operate. However, this manual should be read in full, and the information contained herein understood, before attempting to operate the test lamp in service.

1.2 Special Warnings



Warning: Do not leave battery uncharged. It will result in permanent battery damage.



WARNING: UV light is injurious to one's vision. Do not stare into functioning lamp. Wear eye protection of UV blocking glasses to prevent eye injury.



CAUTION: Do not attempt to recharge the FlameGard 5 Test Lamp in areas where combustible gases or potential explosive gases are located.

1.3 Description

The FlameGard 5 Test Lamp is a battery operated rechargeable test lamp specifically designed to test MSA's UV/IR and Multi-Spectral IR Flame Detectors. The test lamp provides a high-energy, broadband radiation source that emits sufficient energy in both the ultraviolet and infrared spectra to activate UV and/or IR detectors. To simulate the flickering of a fire, the test lamp automatically flashes at various selectable rates.

1.4 Upon Receiving

FlameGard 5 Test Lamp leaves the factory with the battery disconnected. The customer must connect and **fully** charge the battery before use. If you connect the battery and activate the

FlameGard 5 Test Lamp

push button, the RED LED will stay on for 60 seconds. It will continue to do so until the battery has been fully charged.

Since the FlameGard 5 Test Lamp goes to fault mode when a charger is plugging in and no battery is present, you must plug in the battery before the charger.

Make sure to keep the lens and the reflector is kept clean from debris and fingerprints. Grease on the window will absorb the required energy from reaching the flame detector.

Please follow the steps outlined below to connect the battery:

- Loosen the Set Screw on the Cap.
- Unscrew the Cap counterclockwise and remove it from the Body.
- Remove the two screws holding Reflector on the Body.
- Pull the Reflector off to reveal a 4-Pin Connector on the PC Board.
- Plug the 4 wire Connector coming from the Body into the 4 -Pin Connector on the PC board. The pins on the connector align one way only.
- Reposition the Reflector on the Body and tighten 2 screws to hold the Reflector on the Body.
- Reinstall the Cap to the FlameGard 5 Test Lamp Body by screwing it on clockwise.
- Tighten the Set Screw on the Cap.
- Follow Section 5.3 in this Instruction Manual to recharge the battery.

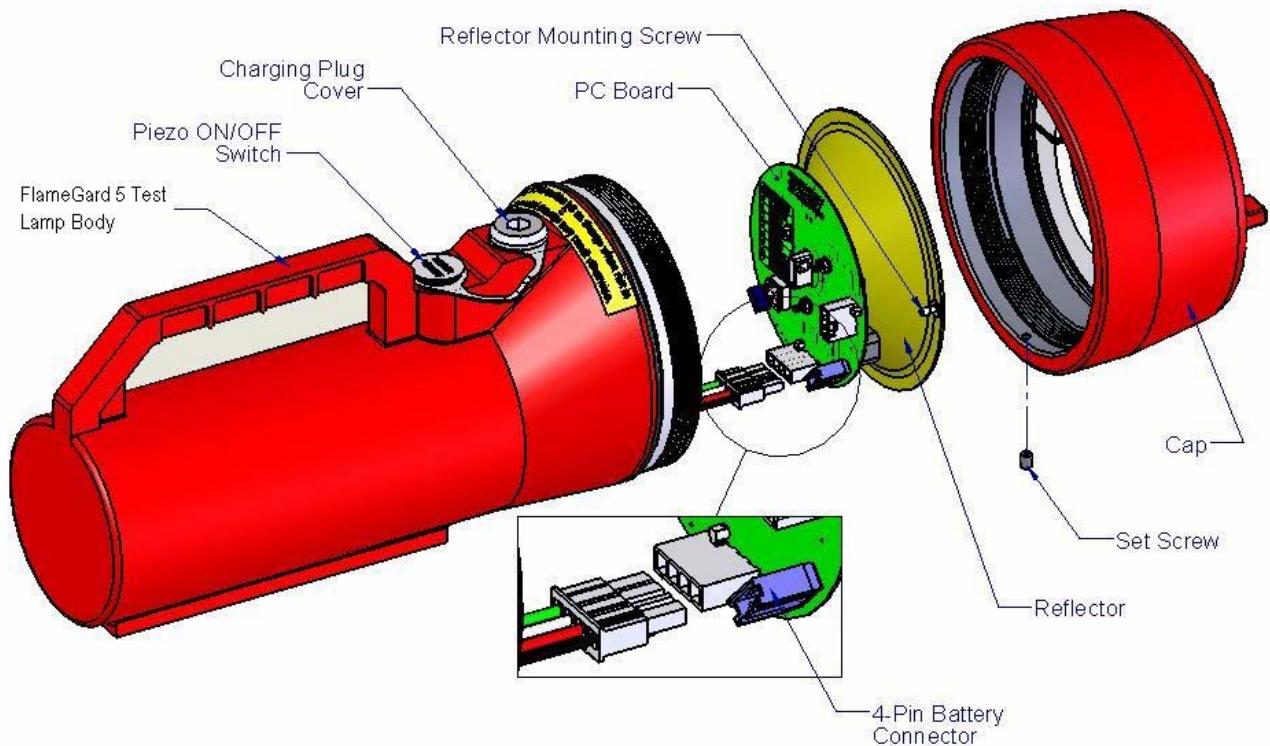

Figure 2: FlameGard 5 Test Lamp Battery Connection

1.5 Test Lamp Operating Principle

A variety of flashing test patterns, selectable through a rotary switch, allows the FlameGard 5 Test Lamp to check the operation of MSA flame detectors. When the specific flashing pattern for a given type of flame detector is appropriately selected, the test lamp triggers the alarm or test mode. Please refer to Table 2 for rotary switch settings.

2.0 Quick Start Guide

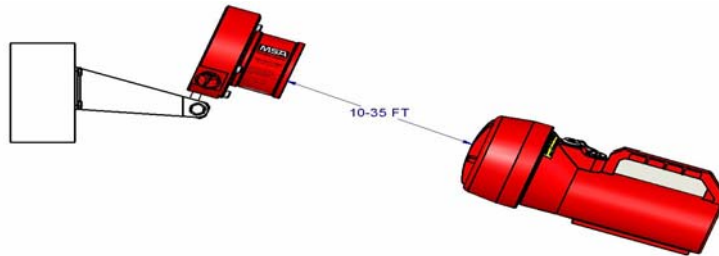

Figure 3: Approximate Distance between a FlameGard 5 Test Lamp and a Flame Detector

It is important to begin a series of flame detector checks with a fully charged Test Lamp.

- Stand between 10 and 35 feet from a Flame Detector that is to be tested and aim the FlameGard 5 Test Lamp directly into the detector window.
- Press the ON button and be sure the high intensity pulsing beam strikes the detector face squarely.
- On some Flame Detectors shaking the lamp from side to side or up and down may increase the simulation of flame flicker and improve the response of the flame detector to the lamp.
- When the Flame Detector senses the Test Lamp, the red LED will blink slowly. The green light may also blink. After a time delay the red LED will start to blink quickly. This signifies the completion of the test.

NOTE: Please refer to Table 2 for maximum distance to each detector.

NOTE: The FlameGard 5 Test Lamp triggers a Flame Detector into alarm. The system must be disabled during test if you do not want false trips.

To conserve charge, do not operate the test lamp longer than is necessary to test a Flame Detector.

When the battery level drops below the level required to maintain the proper intensity of the lamp, an internal low voltage circuit will shut the lamp off until the battery has been recharged. Please refer to Section 5.3 for complete recharging instructions.

It is mandatory that the FlameGard 5 Test Lamp be kept on charge when not in use to prevent excessive battery discharge. The batteries may be charged an average of 500 times before the battery pack is replaced.

NOTE: Please refer to Section 3.8 for Battery Charge State Indicator details.

NOTE: Please refer to Section 5.3 for detailed information on Recharging the Battery. The normal recharge time for the rechargeable battery is 3.5 hours.

3.0 Test Lamp Components

3.1 Lamp Housing Assembly

NOTE: Do not put fingerprints on the reflector or the light bulb, as this will reduce the available radiation required by the individual detector.

The lamp housing assembly consists of a gold-plated parabolic reflector with the lamp affixed to its center. A light emitting diode (LED) that serves as a battery charge indicator is also housed near the edge of the reflector.

3.2 Microcontroller

The FlameGard 5 Test Lamp's flashing patterns are controlled by a microcontroller. This device also monitors battery voltage and shuts down the flash lamp output when the battery charge is low. The microcontroller resides on the functional board.

3.3 Rotary Switch Setting

A rotary switch is used to configure the test lamp to function with FlameGard 5 UV/IR and MSIR Detectors. Positions of the rotary switch for each of these detectors are noted in Table 2 and are labeled next to the rotary switch inside the lamp. The rotary switch resides on the functional board. (Do not operate the Test Lamp in factory mode. Damage may result to the Test Lamp)

3.4 Rechargeable Battery

The FlameGard 5 Test Lamp is powered by a 12V rechargeable battery. It is mandatory to keep the test lamp docked with its battery charger when the test lamp is not being used. This will increase the expected life of the battery and will always keep the test lamp available for immediate use.



Warning: Do not leave battery uncharged. It will result in permanent battery damage.

NOTE: The normal recharge time for the rechargeable battery is 3.5 hours.

3.5 Power Jack

The power jack is located directly under the aluminum cap and can be accessed when the cap is removed. The cap must always be in place when operated in a hazardous location. An Allen wrench is included with the test lamp to unscrew or affix the plug. With the plug removed, the battery can be recharged by connecting the jack to the FlameGard 5 Test Lamp battery charger. The battery charger operates from a 110 – 240 VAC power line.

3.6 Push Button

The push button toggles the lamp ON or OFF. Press the button once to turn the lamp on, and press it again to turn the instrument off. After flashing for a maximum of 5 minutes, the test

lamp will turn itself off. This is to prevent the battery becoming completely discharged if the ON / OFF button is accidentally bumped on.

3.7 Aluminum Case and Cap

The FlameGard 5 Test Lamp red aluminum housing is explosion proof for use in hazardous locations (8.1.3). It can also be used for general-purpose, non-hazardous applications.

3.8 Battery Charge State Indicator

The tri-color LED affixed to the gold parabolic reflector displays the charge state of the battery. The flashing patterns and colors of the signals are shown in Table 1.

Battery Charge	LED Color and Flashing Pattern
Fully charged	Solid green
Charging	Solid yellow
Charging paused	Blinking yellow. This occurs if the battery is too hot (> 60°C)
Fault	Blink red once per second
Discharged	Solid red for one minute after the push button is pressed, then off
Never charged & switch pushed	Solid red for one minute after the push button is pressed, then off
Battery not connected	Solid red for one minute after the push button is pressed, then off
Wrong charger connected	Solid red for one minute after the push button is pressed, then off

Table 1: Charge State Indicator

NOTE: The FlameGard 5 Test Lamp attempts to detect improper chargers. However it can not detect all improper chargers, care must be used to ensure the proper charger is used.

If the improper charger is used, disconnect the charger and wait 1 minute until the red LED goes out before connecting the proper charger.

4.0 Use and Operation

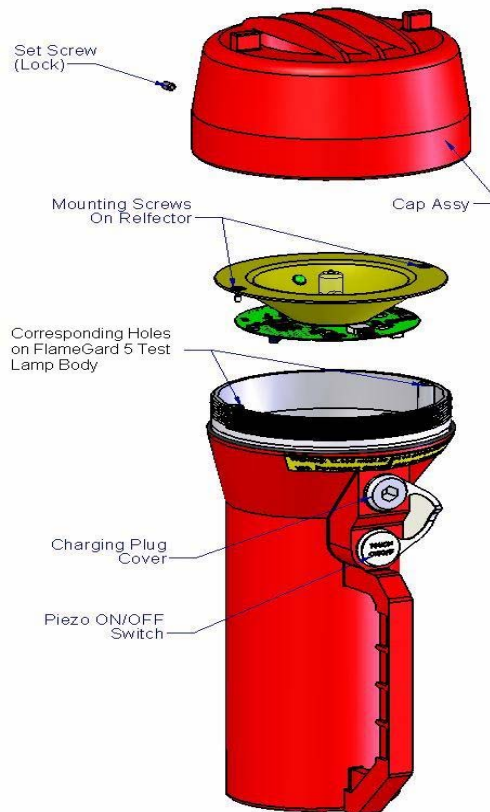

Figure 4: Reflector Mounting in Body

Prior to opening of the test lamp make sure that the set screw located on the cap is loosened sufficiently to remove the cap.

When closing, make sure that the captive screws (located on the reflector) are matched with the holes located on the body of the test lamp.

Before beginning a flame detector check, adjust the rotary switch setting in the FlameGard 5 Test Lamp according to the type of MSA flame detector used. Table 2 shows the rotary switch configurations for MSA flame detectors FlameGard 5 MSIR and FlameGard 5 UV/IR. Using a fully charged FlameGard 5 Test Lamp, stand up to the distance specified in Table 2 from the flame detector to be tested and aim the FlameGard 5 Test Lamp 5 directly into the detector window. Press the ON button and ensure the high intensity intermittent beam strikes the detector face. If the system is operating normally, the instrument will go into a warning condition after a few flashes of the test lamp. If the lamp remains on for the period set by the time delay adjustment, the Flame Detector will go into alarm¹.

¹ For test initiation with the FlameGard 5 MSIR Flame Detector, please refer to the FlameGard 5 MSIR Flame Detector Instruction Manual.

FlameGard 5 Test Lamp

NOTE: Before testing any MSA flame detector, see Table 2 and Figure 5 to ensure the rotary switch setting is correct for the particular detector.



CAUTION: When operating in conditions involving fog, rain or frost, UV and IR radiation are (diminished) with increasing levels of moisture. The moisture level will affect the potential range of the detector. When using the test lamp in conditions of frost, make sure that the lens is free of frost and ice. A plastic card can be used without scratching the lens cap to remove frost build-up.

NOTE: Recharging the battery and normal docking of the test lamp when not in use is mandatory. This will extend the useful life of the battery and also make the test lamp available for immediate use. Normal recharge time is approximately 3 hours; the maximum recharge time is 3.5 hours.

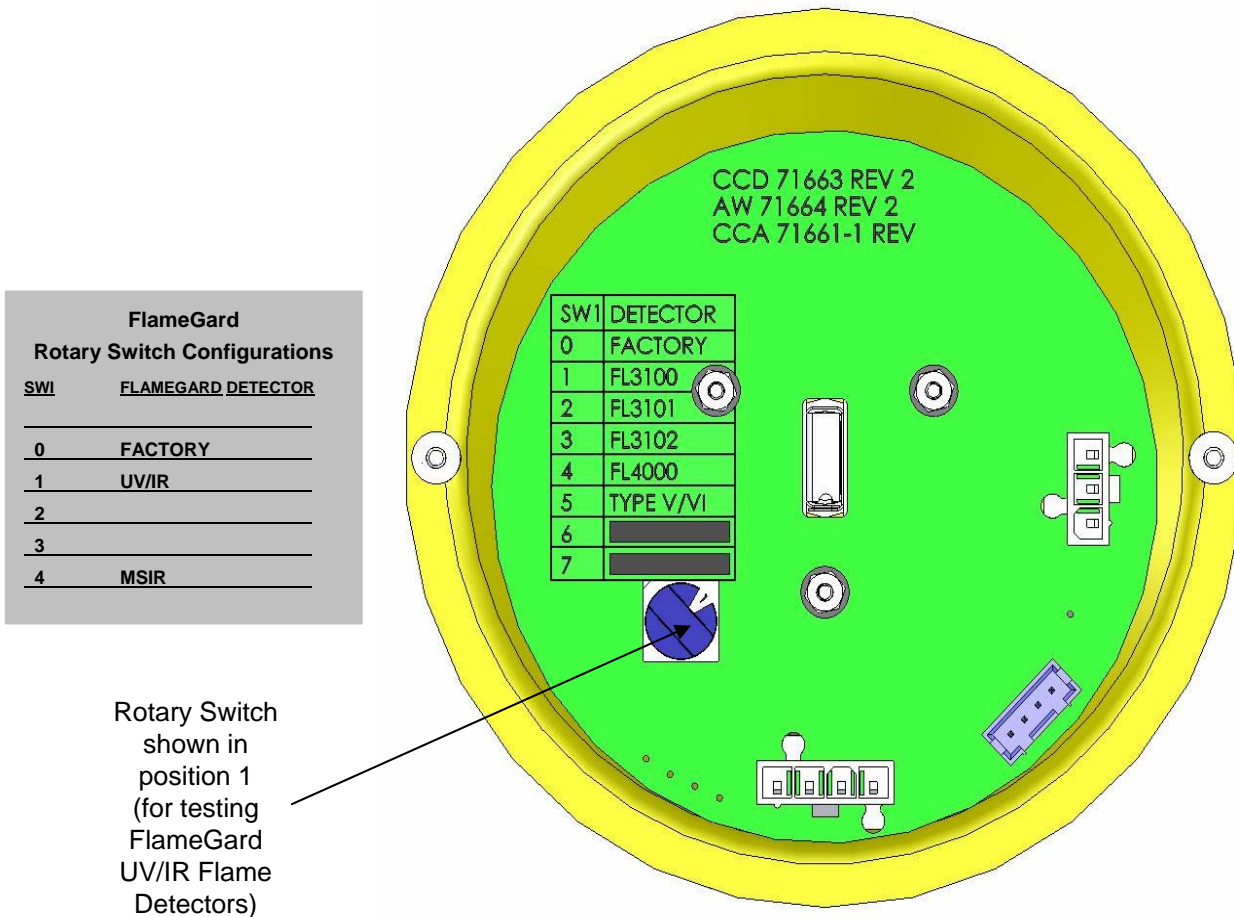

Figure 5: Location of Functional Board under Lamp Assembly

NOTE: Location of the rotary switch in the FlameGard 5 MSIR Flame Detector control board, shown in Figure 5.





Detector Test Mode Initiation or Detector Alarm Trigger with FlameGard 5 Test Lamp			
Flame Detector to Test	Rotary Switch Setting	Maximum Distance to Detector (ft)	Results
FlameGard 5 UV/IR		20	FlameGard 5 UV/IR triggers into alarm mode
FlameGard 5 MSIR		35 (High Sensitivity)	FlameGard 5 MSIR enters test mode
FlameGard 5 MSIR		18 (Medium Sensitivity)	FlameGard 5 MSIR enters test mode
FlameGard 5 MSIR		8 (Low Sensitivity)	FlameGard 5 MSIR enters test mode

Table 2: Detector Test Mode Initiation or/Detector Alarm Trigger with FlameGard 5 Test Lamp

5.0 Test Lamp Maintenance and Warranty

5.1 Maintenance

Routine maintenance for the test lamp is minimal:

- When the test lamp is not being used, it is mandatory to ensure that the test lamp is docked on the charger and the charger is connected to a live 110 – 240VAC power supply adapter. Permanent battery damage will occur if not charged for 60 days.
- Make sure that the test lamp lens is free of frost or large accumulations of moisture during frosty conditions or inclement weather.
- The battery life will be affected by extreme temperatures. Store and charge the battery between +5°C and +30°C (+41°F and 86°F) if possible.

There are no user serviceable parts inside the test lamp. After a number of years, the battery may fail. This will be indicated by a flashing red indicator at the front of the lamp. The unit should be returned to MSA for a replacement battery. If the test lamp is to be discarded, the battery must be recycled at this point.



In most countries it is illegal to dispose of the battery with other garbage. MSA has a Recycle Program in place to recycle the used batteries.

NOTE: The removal of particulate matter and any film buildup on the Sapphire Window is necessary to ensure proper sensitivity of the system. It is recommended that the window be cleaned at least every 30 days if the detector is located in a particularly dirty environment.

5.2 Cleaning the Sapphire Window

A clean, soft, lint-free cloth, tissue or cotton swab should be used to apply the cleaning solution. The window is not glass; it is made from sapphire. The cleaning solution should be MSA P/N 10272-1 (Industrial Strength Windex[®] with Ammonia D).

Do not touch the window with fingers.

1. Wet the window with the solution.
2. Rub with a dry, unsoiled cloth until the window is clean.
3. Completely dry the window.



CAUTION: Do not use a commercial glass cleaner other than Industrial Strength Windex[®] with Ammonia D.

5.3 Recharging the Battery

Before the lamp is used for the first time, or after it has been used to the point where the red LED at the front has come on solidly, the battery must be recharged. To recharge the battery, take the test lamp to a non-hazardous area where there is no possibility of an explosive gas or dust atmosphere being present. The temperature in this area must be between 32°F (0°C) and 104°F (40°C). No damage will occur if the unit is outside the temperature range, but the battery will not charge.

Use an Allen wrench to remove the charging plug stopper and connect the MSA Switching Power Supply P/N 71676-1 to the charging socket exposed by removing the charging stopper.

Plug the Switching Power Supply into an electrical outlet between 100 and 240 VAC 50 to 60 Hz rated to provide at least 1.5 A. The charge indicator LED at the front of the test lamp will change to the color yellow to show that the battery lamp is charging. When the charge is complete (less than 3.5 hours), the charge indicator will change to green. If the lamp is to be stored, leave it connected to the Switching Power Supply to keep the battery charged.

Before using the test lamp, unplug the charging connector from the test lamp, carefully insert the charging plug stopper using an Allen wrench and screw it all the way into the hole. Do not over-tighten the stopping plug. The lamp can now be safely used in hazardous locations as specified on the test lamp nameplate and in Section 8.1.3 of this manual.

5.4 Obtaining Service

The FlameGard 5 Test Lamp contains no user serviceable parts. To obtain information regarding factory service, contact MSA or your MSA representative. Please have the following information available:

- Instrument model number (on the nameplate)
- Instrument serial number (on the nameplate)
- Description of the problem

5.5 Warranty



Caution: There are no user serviceable parts inside the FlameGard 5 Test Lamp. Work performed by persons not authorized by MSA will void the warranty.

MSA warrants the FlameGard 5 Test Lamp and the accessory battery charger to be free from defects in workmanship or material under normal use and service within two (2) years from the date of shipment.

MSA will repair or replace without charge any equipment found to be defective during the warranty period. Full determination of the nature of, and responsibility for, defective or damaged equipment will be made by MSA personnel.

Defective or damaged equipment must be shipped prepaid to MSA or the representative from which shipment was made. In all cases, this warranty is limited to the cost of the equipment

FlameGard 5 Test Lamp

supplied by MSA. The customer will assume all liability for the misuse of this equipment by its employees or other personnel.

All warranties are contingent upon proper use in the application for which the product was intended and do not cover products which have been modified or repaired without MSA approval or which have been subjected to neglect, accident, improper installation or application, or on which the original identification marks have been removed or altered.

EXCEPT FOR THE EXPRESS WARRANTY STATED ABOVE, MSA DISCLAIMS ALL WARRANTIES WITH REGARD TO THE PRODUCTS SOLD, INCLUDING ALL IMPLIED WARRANTIES OF MERCHANTABILITY AND FITNESS AND THE EXPRESS WARRANTIES STATED HEREIN ARE IN LIEU OF ALL OBLIGATIONS OR LIABILITIES ON THE PART OF MSA FOR DAMAGES INCLUDING, BUT NOT LIMITED TO, CONSEQUENTIAL DAMAGES ARISING OUT OF / OR IN CONNECTION WITH THE USE OR PERFORMANCE OF THE PRODUCT.

6.0 Troubleshooting Guide

The following table lists potential problems that can affect the test lamp circuit. Follow the individual steps to pinpoint and define circuit ailments.

This section is intended to be a guide in correcting problems, which may arise in the field. MSA should be contacted for assistance if the corrective action listed does not eliminate the problem.

Condition	Possible Solution
Test lamp does not flash	Battery may require a recharge
Test lamp flashes but is unable to trigger detector	Check Table 2
	Verify that rotary switch settings are set as specified in Table 2
Test lamp does not flash, and battery has been recharged for 4 hours	Lamp filament may be broken. Check power and lamp connectors
During charging the charge indicator lamp at the front of the unit flashed red	The test lamp must be returned to MSA for a replacement battery pack
During charging the charge indicator lamp flashes yellow. Charging is not complete after 4 hours.	The unit is too hot. If the battery temperature is above 60°C (140°F) the charging pauses until the battery pack cools. Put the lamp into a cooler location or wait until the indicator turns green (this could take more than 10 hours)
Lamp stops flashing after 5 minutes of use	This is an intentional part of the design to prevent the lamp draining the battery if the on/off button is knocked. Press the on/off button again and the lamp will resume flashing
During operation the lamp stops flashing and the charge indicator is solid red	The battery has been discharged. Recharge the battery, in a non-hazardous location, using the MSA battery charger
When activating the push button, the RED LED is on for one minute.	<ol style="list-style-type: none"> 1-The battery needs charging 2-The battery was just plugged in and has not been fully charged 3- The battery is not connected 4- The wrong charger maybe in used instead of the test lamp charger

Table 3: Troubleshooting Table

7.0 Customer Support

7.1 MSA Office

Address	Phone/Email
UNITED STATES	
Mine Safety Appliances Co. 26776 Simpatuca Circle Lake Forest, CA 92630	Toll Free: 1-800-MSA-INST Email: customer.service@msanet.com

7.2 Other Sources for Help

MSA provides extensive documentation, white papers, and product literature for the company's complete line of safety products. Many of these documents are available online at the MSA website at <http://www.msanet.com>.

8.0 Appendix

8.1 Specifications

Electrical specification	12 VDC 130 W Max
Operating temperature:	5°F to +122°F (-15°C to +50°C)
Storage temperature:	5°F to +122°F (-15°C to +50°C)
Charging temperature	32°F to +104°F (0°C to +40°C)
Humidity range:	0 to 90% ± 3% RH, non-condensing
Weight:	7.9 lb (about 3.5 kg)
Dimensions:	13" L x 5" D (330 mm L x 127 mm D)
Approvals:	CSA, ATEX, and CE Mark
Charging time:	3.5 hours
Output spectra:	Broadband emissions in UV, visible and IR
Charger input:	110 – 240 VAC, 50/60Hz @1.5 A
Output:	24 VDC @ 2.1 A
Detection range:	See Table 2 for maximum distance per flame detector model

8.1.1.1 Regulatory Agency Approvals

8.1.2 Regulatory Agencies

The FlameGard 5 Test Lamp is certified by the following regulatory agencies:

- ATEX – Hazardous Locations
- Canadian Standards Association (CSA) – Hazardous Locations

8.1.3 Classification Area and Protection Methods

The FlameGard 5 Test Lamp is certified as follows:

- Protection Method Ex d IIB+H₂
 Ex tD A21 IP 6X T110°C
- Area Classifications Class I, Division 1 and 2, Groups C and D
- Conforms With Electromagnetic Compatibility Directive (89/336/EEC)

PLEASE NOTE:

The following instructions apply to equipment covered by certificate # Sira 10 ATEX1364

- The equipment may be used with flammable gases and vapors with apparatus groups IIB+ H₂ and with temperature class T4.
- The equipment is only certified for use in ambient temperatures in the range -15°C to +50°C (5°F to +122°F) and should not be used outside this range.
- Installation shall be carried out by suitably-trained personnel in accordance with the applicable code of practice e.g. EN 60079-14:1997.
- Inspection and maintenance of this equipment shall be carried out by suitably trained personnel in accordance with the applicable code of practice e.g. EN 60079-17.
- Repair of this equipment shall be carried out by suitably trained personnel in accordance with the applicable code of practice e.g. EN 60079-19.